

DC-DC CONVERTER ACR 150

RAILWAY CONVERTER.

FOR PCB MOUNTING



HIGHLIGHTS

- + Output Power up to 150 Watts**
- + Efficiency up to 92%
- + High Power Density
- + Wide Input Range
- + Wide Temperature Range
- + RoHS compliance
- + According to EN50155

INPUT

Input Voltage Nominal 12 VDC, 12/24 VDC, 24 VDC, 72 VDC, 110 VDC

OUTPUT

Output Voltage 5 V / 12 V / 24 V

Initial Set Accuracy < 1%*

Minimum Load No minimum load

Line Regulation < 1%

Load Regulation < 1% (0% - 100% load)

Ripple & Noise < 1% pk-pk, 20 MHz bandwidth*

Start Time < 90 ms

Max. Output Capacitance 500 uF x I_{out max}

Temperature Coefficient 0.02%/°C

FEATURES

Sync	The switching frequency can be synchronized to -5% (-10%, no positive trimming) and +10% of the nominal frequency.
Enable Signal	Pulled to low (<0,8V ref. to Vin-) disables the converter. Open pin enables the converter.
Thermal Warning Signal	An open-collector output pulls to Vin- when the baseplate reaches the temperature of 5-10°C below the OTP.
Sense + / -	Remote sense to compensate for lead drops of the output line up to 0,5 V.
Trim	A resistor-programmable input to trim the output voltage in the range of +10% / - 20%.
Share	Up to 3 converters can be connected in parallel sharing within < 10% at 90% load. Each converter max. 90% load.

* For T_{amb} = 25°C, V_{in nom}, I_{out nom}

** The maximum ambient temperature without additional cooling

$$T_{amb} = 100^{\circ}\text{C} - 6,5 \frac{^{\circ}\text{C}}{\text{W}} \times P_{out} (\text{W}) \left(\frac{100\%}{\eta(\%) } - 1 \right)$$

$$P_{out} = (100^{\circ}\text{C} - T_{amb}) / (6,5 \times \left(\frac{100\%}{\eta(\%) } - 1 \right))$$

Also with heatsink, ensure that baseplate not exceed 100°C

*** In built-in condition our devices may show different EMC properties

PROTECTION

Over Voltage Protection (OVP) 120-130% V_{out nom}, latched (independent of the trimmed voltage).

Over Current Protection (OCP) I_{out nom} > 105%. The output switches-off when V_{out nom} < 70% (at V_{out nom} = 5V < 80%) and restarts automatically latest after 0.5 s of elimination of the overload.

Over Temperature Protection (OTP) Shutdown at +100 -105°C baseplate with approx. 5°C hysteresis and auto recovery.

GENERAL

Product Standard	EN 50155:2007
Isolation	2200 VDC Input to Output 1500 VDC Input to Baseplate 710 VDC Output to Baseplate
Switching Frequency	Typ. 400 kHz
Dimensions [mm]	95,0 x 65,0 x 11,0
Weight	approx. 170 g
MTBF	1.800.000h acc. to IEC/TR 62380 (25°)

ENVIRONMENTAL

Operating Ambient Temp.	-40°C to +85°C**
Operating Case Temp.	-40°C to +100°C
Storage Temperature	-55°C to +100°C
Vibration / Shock / Bump	EN 61373:1999, Cat. 1B

EMC & SAFETY

EMC Standard	EN 50121-3-2:2006
Conducted Emissions	EN 55011:2007+A2:2007, Class A (Quasi Peak)***
ESD Immunity	EN 61000-4-2:1995+A1:1998+A2:2001, level 3 (6kV/8kV), Criteria B
Burst	EN 61000-4-4:2004, level 3 (2kV), Criteria A
Surge	EN 50121-3-2:2006, line to line ±1kV, 42R, and line to case ±2kV, 42R, Criteria B EN 61000-4-5:2006, level 1, ±0,5kV (except V _{in} = 36V, 72V, 110V)
Conducted Immunity	EN 61000-4-6:2007, level 3 (10V), Criteria A

TECHNICAL DATA

For $T_{amb} = 25^{\circ}C$, $V_{in nom}$, $I_{out nom}$ unless otherwise specified.

SPECIFICATION Input 6 - 20 VDC (12 Vin nom)

		ACR150 12S24*			
		71 41 24 0322 6			
CHARACTERISTIC		Unit	Min	Typ	Max
INPUT	Input Voltage Operating	V		8,4...18,0	
	Input Voltage Range	V		6...20 (t ≤ 30,0 sec.)	
	Under Voltage Turn-on	V		< 9	
	Under Voltage Turn-off	V		< 6	
	Input Current @ Vin nom	A		9,05	
	Input Current @ Vin = 6 V	A		16,5	
	Input Current @ No Load	mA		120	
	Disabled Input Current	mA		5,0	
	Recommended External Fuse	A		20	
	OUTPUT	Output Voltage	V		24,0
Output Current		A			3,8**
Output Power		W			91,2
Efficiency @ Pout (80%)		%		85	
Efficiency @ Pout (100%)		%		84	
Transient Response 25% / 75% Load Step, Recovery Time < 500 us		mV		±720	

SPECIFICATION Input 9 - 36 VDC (12/24 Vin nom)

		ACR150 12/24S05*			ACR150 12/24S12*			ACR150 12/24S24				
		73 41 08 0322 1			73 41 12 0322 5			73 41 24 0322 1				
CHARACTERISTIC		Unit	Min	Typ	Max	Min	Typ	Max	Min	Typ	Max	
INPUT	Input Voltage Operating	V		10...36								
	Input Voltage Range	V		9...40 (t ≤ 1,0 sec.)								
	Under Voltage Turn-on	V		< 10								
	Under Voltage Turn-off	V		< 9								
	Input Current @ Vin nom = 24 V	A		3,83		5,68				5,88		
	Input Current @ Vin nom = 12 V	A		7,6		11,3				11,76		
	Input Current @ Vin = 9 V	A		10,3		15,5				16,0		
	Input Current @ No Load (24 V)	mA		80		120				80		
	Input Current @ No Load (12 V)	mA		100		130				100		
	Disabled Input Current	mA		5,0		5,0				4,0		
Recommended External Fuse	A		20									
OUTPUT	Output Voltage	V		5,0		12,0				24,0		
	Output Current	A			16,0			10,0			5,0	
	Output Power	W			80			120			120	
	Efficiency (24V) @ Pout (80%)	%		87		88				87		
	Efficiency (12V) @ Pout (80%)	%		88		89				86		
	Efficiency (24V) @ Pout (100%)	%		87		88				85		
	Efficiency (12V) @ Pout (100%)	%		88		89				85		
Transient Response 25% / 75% Load Step, Recovery Time < 500 us	mV		±200		±360				±500			

* preliminary

** $V_{in} = 6...8,4 V$ $I_{out max} = 3,3 A$

TECHNICAL DATA

For $T_{amb} = 25^{\circ}\text{C}$, $V_{in\ nom}$, $I_{out\ nom}$ unless otherwise specified.

SPECIFICATION Input 14,4 - 40 VDC (24 Vin nom)

TYPE		ACR150 24S05			ACR150 24S12			ACR150 24S24			
ORDER NUMBER		72 41 08 0522 3			72 41 12 0522 7			72 41 24 0522 3			
CHARACTERISTIC		Unit	Min	Typ	Max	Min	Typ	Max	Min	Typ	Max
INPUT	Input Voltage Operating	V	16,8...36								
	Input Voltage Range	V	14,4...40 ($t \leq 1,0$ sec.)								
	Under Voltage Turn-on	V	< 14,4								
	Under Voltage Turn-off	V	< 14,0								
	Input Current @ Vin nom = 24 V	A		4,26			7,02			7,02	
	Input Current @ Vin = 14,4 V	A		7,20			12,0			12,0	
	Input Current @ No Load	mA		130			170			60	
	Disabled Input Current	mA		4,0			5,0			5,0	
	Recommended External Fuse	A	16								
OUTPUT	Output Voltage	V		5,0			12,0			24,0	
	Output Current	A			18			12,5			6,25
	Output Power	W			90			150			150
	Efficiency @ Pout (80%)	%		89			90			90	
	Efficiency @ Pout (100%)	%		88			89			89	
	Transient Response 25% / 75% Load Step, Recovery Time < 500 us	mV		± 300			± 500			± 1000	

SPECIFICATION Input 43 - 101 VDC (72 Vin nom)

TYPE		ACR150 72S05*			ACR150 72S12*			ACR150 72S24			
ORDER NUMBER		76 41 08 0322 7			76 41 12 0322 2			76 41 24 0322 7			
CHARACTERISTIC		Unit	Min	Typ	Max	Min	Typ	Max	Min	Typ	Max
INPUT	Input Voltage Operating	V	50,4...93,6								
	Input Voltage Range	V	43...101 ($t \leq 1,0$ sec.)								
	Under Voltage Turn-on	V	< 50,4								
	Under Voltage Turn-off	V	< 43,0								
	Input Current @ Vin nom = 72 V	A		1,41			2,31			2,31	
	Input Current @ Vin = 43 V	A		2,38			3,95			3,95	
	Input Current @ No Load	mA		50			60			45	
	Disabled Input Current	mA		5,0			5,0			4,0	
	Recommended External Fuse	A	6								
OUTPUT	Output Voltage	V		5,0			12,0			24,0	
	Output Current	A			18			12,5			6,25
	Output Power	W			90			150			150
	Efficiency @ Pout (80%)	%		89			90			90	
	Efficiency @ Pout (100%)	%		89			90			90	
	Transient Response 25% / 75% Load Step, Recovery Time < 500 us	mV		± 300			± 500			± 720	

SPECIFICATION Input 66 - 154 VDC (110 Vin nom)

TYPE		ACR150 110S05			ACR150 110S12			ACR150 110S24			
ORDER NUMBER		77 41 08 0522 4			77 41 12 0522 8			77 41 24 0522 4			
CHARACTERISTIC		Unit	Min	Typ	Max	Min	Typ	Max	Min	Typ	Max
INPUT	Input Voltage Operating	V	77...138								
	Input Voltage Range	V	66...154 ($t \leq 1,0$ sec.)								
	Under Voltage Turn-on	V	< 77,0								
	Under Voltage Turn-off	V	< 66,0								
	Input Current @ Vin nom = 110V	A		0,92			1,48			1,52	
	Input Current @ Vin = 66 V	A		1,53			2,50			2,55	
	Input Current @ No Load	mA		45			50			25	
	Disabled Input Current	mA		4,0			4,0			4,0	
	Recommended External Fuse	A	4								
OUTPUT	Output Voltage	V		5,0			12,0			24,0	
	Output Current	A			18			12,5			6,25
	Output Power	W			90			150			150
	Efficiency @ Pout (80%)	%		90			92			89	
	Efficiency @ Pout (100%)	%		89			92			90	
	Transient Response 25% / 75% Load Step, Recovery Time < 500 us	mV		± 300			± 650			± 1000	

*preliminary

TECHNICAL DATA

For $T_{amb} = 25^{\circ}\text{C}$, $V_{in\ nom}$, $I_{out\ nom}$ unless otherwise specified.

MECHANICAL DETAILS

- Dimensions are in mm.
- Unless otherwise specified, general tolerances $\pm 0,5$ are for values in brackets (XX).
Values not in brackets are according to ISO 2768-1m.

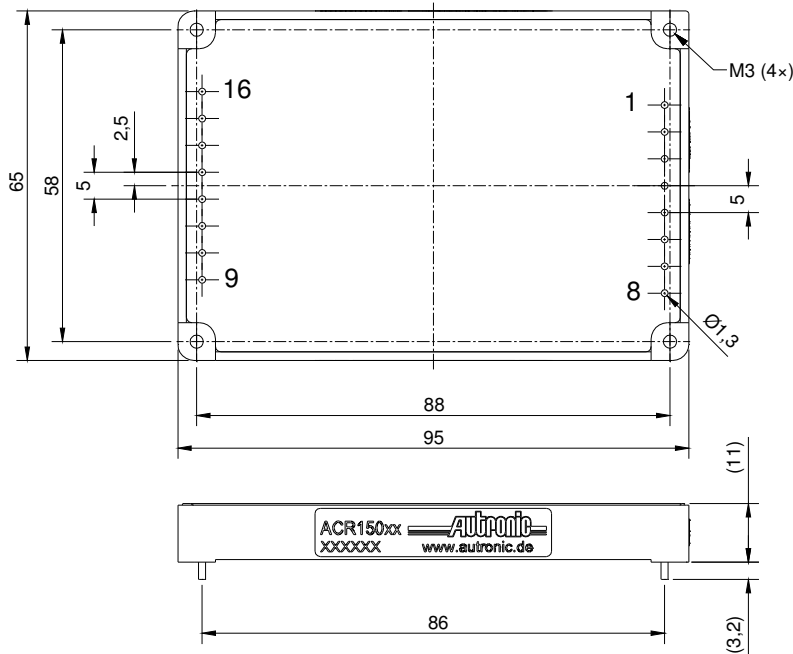

Pin - Material:	Tin plated brass
Case - Frame:	Pocan B4235, 30GF, UL94-V0, black
Baseplate:	Copper brushed and nickel plated
Resin compound:	Polyurethane black, UL94-V0, EN45545-2:2016-02 HL-HL2-HL3 (R24)

PINNING

Pin	Function	Pin	Function
1	Base-plate Potential of the Baseplate	9	+S Positive Sense
2	Sync Sync. of Switching Frequency	10	+V _{out} Positive Output Voltage
3	-V _{in} Negative Input Voltage	11	+V _{out} Positive Output Voltage
4	-V _{in} Negative Input Voltage	12	Trim Output Voltage Trimming
5	+V _{in} Positive Input Voltage	13	-V _{out} Negative Output Voltage
6	+V _{in} Positive Input Voltage	14	-V _{out} Negative Output Voltage
7	EN Enable Signal	15	-S Negative Sense
8	TW Thermal Warning Signal	16	Share Current sharing

BLOCK DIAGRAM

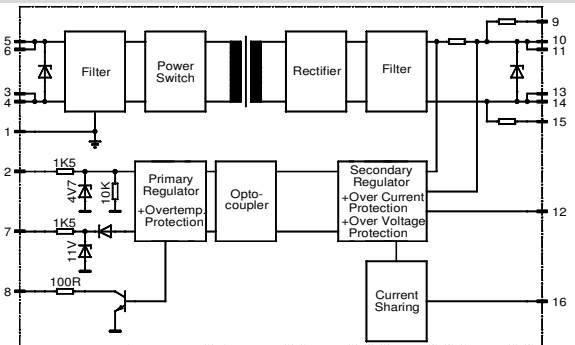

NOTES

Installation Instructions:

The converters have to be installed according to the guidelines currently in force, like other open electronic component assemblies. Attention must be paid to sufficient ventilation, carry off heat, fastening and protection against accidental contact. The mounting surface must be flat and able to remove the thermal energy of the baseplate (baseplate temperature must not exceed $+100^{\circ}\text{C}$).

The pin 1, baseplate: (/), has to be properly connected to Chassis/Earth in order to assure operation.

External Fuse:

For input protection a time-lag fuse corresponding to IEC 60127-2 must be installed. For recommended rating of the fuse refer specification table above. Pay attention on sufficient current of current source in case of short-circuit!



A FORTEC GROUP MEMBER

DESCRIPTION OF FEATURES

For $T_{amb} = 25^{\circ}C$, $V_{in nom}$, $I_{out nom}$ unless otherwise specified.

SYNC

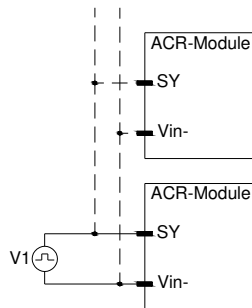

- V1: - square signal
 - level 4...6 V / > 1 mA
 - min. pulse length 200 ns

When not in use, leave Sync pin not-connected.

ENABLE SIGNAL

The module may be disabled by pulling EN below 0,8 V with respect to the -Input. This may be done with an open collector transistor, relay, optocoupler, or an external control voltage (V1).

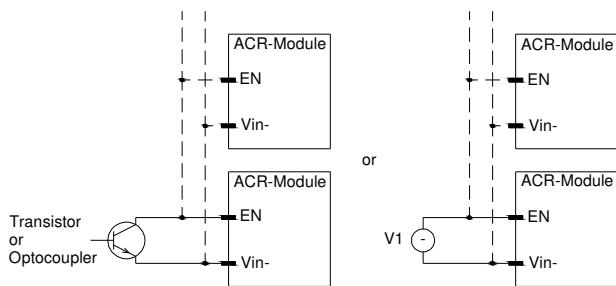

- Open-collector:
 Leakage current ≤ 1 mA
 Min. $V_{CE0} \geq 20$ V

- V1:
 4...10 V (Enable active)
 0...0,8 V (Enable inactive)

When not in use, leave Enable pin not-connected.

THERMAL WARNING SIGNAL

- Maximum ratings
 V_{TW} to V_{in} : 0...200 V
 I_{TW} : ≤ 20 mA

When not in use, leave Thermal Warning pin not-connected.

SENSE +/-

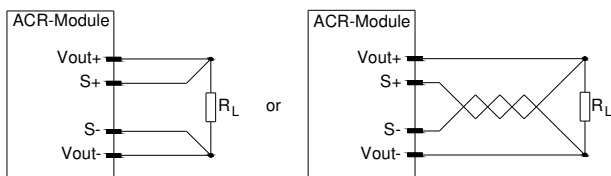

When not in use, leave Sense pin not-connected.

DESCRIPTION OF FEATURES

For $T_{amb} = 25^{\circ}\text{C}$, $V_{in\ nom}$, $I_{out\ nom}$ unless otherwise specified.

TRIM

The output voltage of the converter can be adjusted or programmed via fixed resistors or potentiometers - see table below.

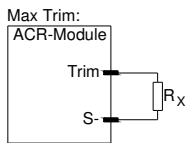

The resistor must be connected to the -Sense pin.

$$R_x [k\Omega] = \frac{a(V_{out} - V_{Trim}) + b}{V_{Trim} - V_{out}}$$

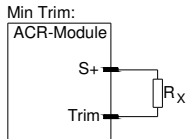

The resistor must be connected to the +Sense pin.

$$R_x [k\Omega] = \frac{c(V_{Trim} - V_{out}) + d}{V_{out} - V_{Trim}}$$

Table of parameters

	a	b	c	d
ACR150 (xx)S05	3,856	2,089	5,384	6,097
ACR150 (xx)S12	6,922	10,728	9,823	26,364
ACR150 (xx)S24	16,944	46,697	24,497	139,461

When not in use, leave Trim pin not-connected.

SHARE

The Share pin supports paralleling for increased power (max. 90% load per converter).

Modules of the same input voltage, output voltage and power level will current share if all Share pins are suitably interfaced.

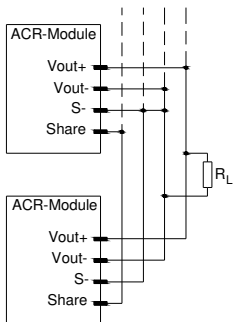

After overload switch-off, the converters should be restarted by enable signal or input voltage.

Connection should be as short as possible.

When not in use, leave Share pin not-connected.

APPLICATION NOTES

HOLD-UP-TIME

Many applications require the power supply to maintain output regulation during a momentary power failure of specified duration.

Here an application-circuit to get a hold-up-time and also a reverse-polarity-protection:

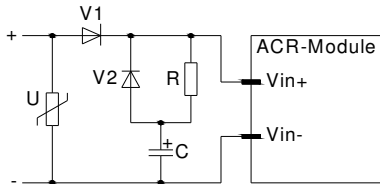

U – varistor for surge protection

C – hold-up capacitance (dependent of V_{in} and P_{out})

V1 – inverse-polarity diode, also avoiding backward current

V2, R – prevent high inrush current

Recommendation:

Capacitor C: Energy is calculated : $E = \frac{1}{2} * C * (U_{nom}^2 - U_{min}^2)$ and should be calculated with the nominal and minimum input voltage of the converter.

Low ESR-Capacitors are required, also there must be paid attention to the low temperature usability of the selected capacitor.

Recommended value of the capacitor is 150% of the calculated value.

Varistor: Should be selected to protect the circuit against Surge-Pulses.

Diode V1: Should be able to handle the max. input current. Also to withstand the maximum negative voltage added to the hold-up-voltage (e.g. at a neg. surge – event).

Resistor R: Have to be capable to handle the power-loss peak while charging the capacitor at power on (pulse-proof type).

REVERSE POLARITY PROTECTION

To get a reverse polarity protection, a serial diode like V1 in the circuit above, is the simplest way.

But for low voltage input this solution has a lot of power dissipation. A MOSFET can be used to bridge the diode in the operating mode.

Detailed information and recommendations on demand.

EMC

Conducted emissions	EN55011:2007+A02:2007 Class A, average with external components More information under www.autronic.de/support/ACR
Radiated emissions	EN55011:2007+A02:2007 Class A with external components More information under www.autronic.de/support/ACR